

# N180 G+F



200 cm

8 mm

1,5 cm

Soft closing

## CORNER ENTRY ENCLOSURE, 1 HINGED DOOR + SIDE PANEL

Design Marco Pellici

Dimensions					Code	Glass	Profile					
Actual size		Side panel	Access	Door projection		1	U	B	K	H	O M L	P R Q N Z
<b>A</b>	<b>G</b>	<b>F</b>	*	<b>B</b>		Clear	Matt White	Silver	Chrome	Matt Black	Shiny gold Shiny red gold Shiny black chrome	Brushed gold Brushed red gold Brushed bronze Brushed black chrome Brushed inox

DOOR												
78↔79,5	76,9↔78,4		61	60	<b>N180G80-</b>							
88↔89,5	86,9↔88,4		71	70	<b>N180G90-</b>							
98↔99,5	96,9↔98,4		81	80	<b>N180G100-</b>							

H 200			SPECIAL	<b>N180GSP</b>								
-------	--	--	---------	----------------	--	--	--	--	--	--	--	--

SIDE PANEL												
	76,5↔78	78↔79,5	-	-	<b>N180FG80-</b>							
	86,5↔88	88↔89,5	-	-	<b>N180FG90-</b>							
	96,5↔98	98↔99,5	-	-	<b>N180FG100-</b>							
	116,5↔118	118↔119,5	-	-	<b>N180FG120-</b>							

H 200			SPECIAL	<b>N180FGSP</b>								
-------	--	--	---------	-----------------	--	--	--	--	--	--	--	--

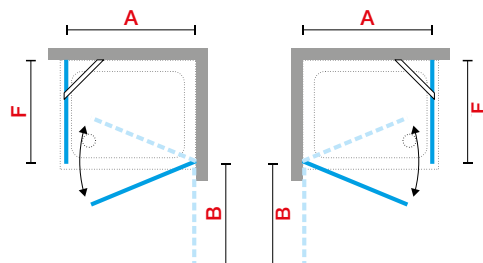
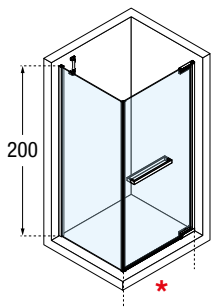

**A / F**  
Actual size  
**G**  
Glass centered

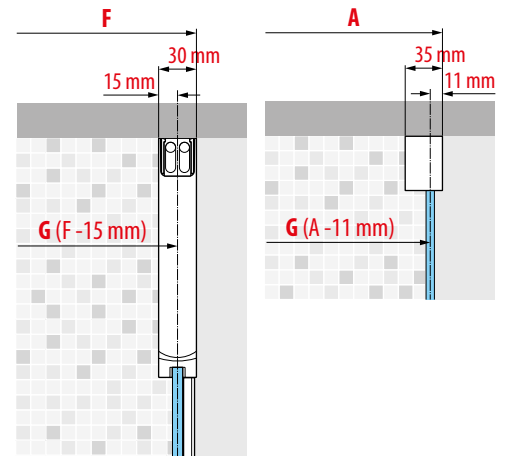



CLEAR / SHINY GOLD

**GLASS TYPE**



Clear  
code 1

**PROFILE COLOURS**



Matt white  
code U



Silver  
code B



Chrome  
code K



Matt black  
code H

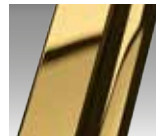

Shiny gold  
code O



Shiny red gold  
code M



Shiny black  
chrome  
code L

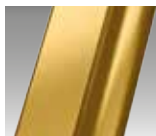

Brushed gold  
code P



Brushed red  
gold  
code R

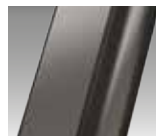

Brushed black  
chrome  
code N

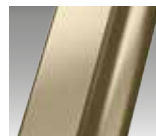

Brushed bronze  
code Q



Brushed inox  
code Z